

Cylinder Stands

M, M60, H & T CYLINDER SIZE

Models below are new concepts in cylinder floor stand designs. **NO MORE** damaged floors or carpets from rusty cylinder bottoms. **NO MORE** lifting heavy stands up over the top of cylinders. **NO MORE** damaged gauges or regulators. **NO MORE** unsafe cylinder "ride up" on the stand due to unsafe steel thumbscrews causing gouging, scraping and marring of cylinders (especially aluminum cylinders). The cylinders can be rolled on or off with ease and firmly locked in place, or quickly unlocked with our **PATENTED** cylinder placement band and large plastic turning knobs.

ENVIRONMENTALLY SAFE COLOR COATINGS

THIS **PATENTED** STAND HOLDS A
7" TO 9-1/2" CYLINDER.

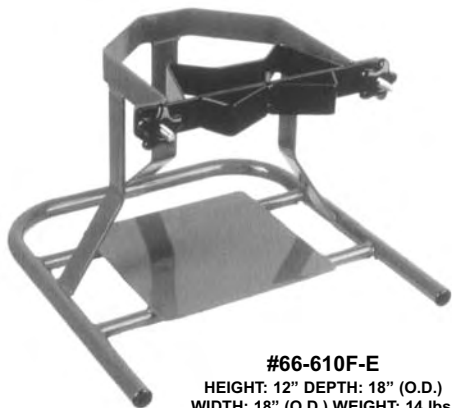

#66-610F-E
HEIGHT: 12" DEPTH: 18" (O.D.)
WIDTH: 18" (O.D.) WEIGHT: 14 lbs.

This side is used to hold a
7" to 8-1/2" dia. cylinder.
(M or M60)

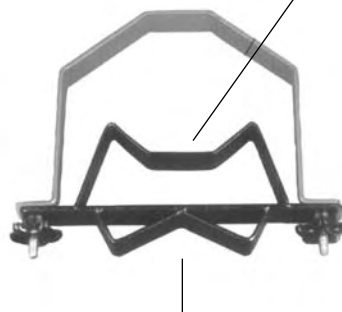

This side is used to hold a
9" to 9-1/2" dia. cylinder.
(H or T)

M, M60, H & T SIZE HIGH PRESSURE CYL. ROLLING STANDS

The **#66-610FW-E** and **#66-610FW-H** are newly modified (by popular demand) with removable heavy-duty 3" x 1.50" rubber tired (125 lb.ea. L/R) casters for easier rolling over carpets and in and out of elevators.



#66-610FW-E
HEIGHT: 12" DEPTH: 18" (O.D.)
WIDTH: 18" (O.D.) WEIGHT: 24 lbs.

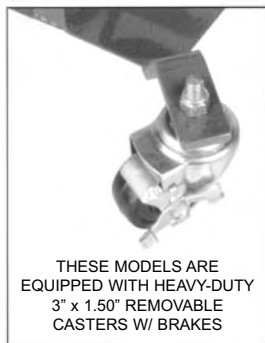

THESE MODELS ARE
EQUIPPED WITH HEAVY-DUTY
3" x 1.50" REMOVABLE
CASTERS W/ BRAKES

#66-610FW-H
HEIGHT: 48" DEPTH: 18" (O.D.)
WIDTH: 18" (O.D.) WEIGHT: 25 lbs.



Cylinder Stands

NEWLY DEVELOPED and much needed M4, M6 & B stands are designed for multiple cylinder storage. The all-welded construction of heavy gauge materials insure greater durability and strength. Individual spacing, positive cylinder placement and weight distribution gives these units the right formula for safe storage.



#66-6060-M6
HEIGHT: 19.5" DEPTH: 10"
WIDTH: 12" WEIGHT: 11 lbs.
CYL. CAP: (6) M4 / M6 / B



#66-6120-M6
HEIGHT: 19.5" DEPTH: 12"
WIDTH: 18" WEIGHT: 16 lbs.
CYL. CAP: (12) M4 / M6 / B

#66-6100-M6
HEIGHT: 12" DEPTH: 20"
WIDTH: 8" WEIGHT: 10 lbs.
CYL. CAP: (10) M4 / M6 / B



SOLD SEPARATELY



FOR TRUCK / VAN MOUNTING

#66-PB-10M6
HEIGHT: 7" DEPTH: 21"
WIDTH: 9" WEIGHT: 10 lbs.
HOLDS (1) 6100-M6 RACK

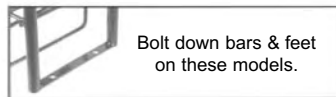

Bolt down bars & feet on these models.



#66-6300-M6
HEIGHT: 16" DEPTH: 23"
WIDTH: 19" WEIGHT: 30 lbs.
CYL. CAP: (30) M4 / M6 / B

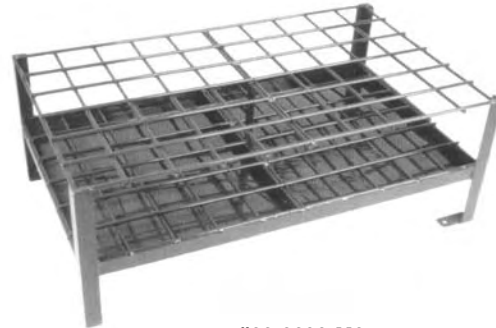

#66-6600-M6
HEIGHT: 16" DEPTH: 39"
WIDTH: 23" WEIGHT: 60 lbs.
CYL. CAP: (60) M4 / M6 / B

BUMPER GUARD KITS FOR ANTHONY M4, M6 & B SIZE CYL. CARTS AND STANDS



Anthony has developed a unique cylinder protection system for its multiple cylinder carts, cylinder stands and racks. These newly designed plastic bumper guards (PATENT PENDING) help protect the surfaces of steel and aluminum cylinders from being scratched, gouged, scraped, or marred. These bumpers also eliminate the clanging noise when cylinders are in transport. **NOTE:** These retrofit bumper guards easily snap into place and **do not come off.**

BUMPER GUARD KIT PART NO.	FITS ANTHONY MODELS	BUMPERS PER KIT	CYLINDER CAPACITY
#66-BG-30M6	#66-6300-M6, #66-6304-M6	142	30
#66-BG-60M6	#66-6600-M6, #66-6604-M6	284	60
#66-BG-10M6	#66-6100-M6	54	10
#66-BG-06M6	#66-6060-M6	34	6
#66-BG-12M6	#66-6120-M6	62	12

Cylinder Stands

These heavy-duty modular cylinder racks are ruggedly constructed and have been designed to be anchored to the floor or bolted together, expanding your cylinder handling needs. Constructed of heavy-gauge 1-1/2" square tubing, 12 gauge steel floor plate and heavy-duty welded loop safety chain with spring loaded safety latches to secure each cylinder individually.

HOLDS HIGH & LOW PRESSURE CYLINDERS UP TO 9 1/2" IN DIA.

SAFETY:

- * COMPLIES WITH ALL SEISMIC ZONE 4 REGULATIONS IN THE UNIFORM BUILDING CODE (UBC).
- * MEETS OR EXCEEDS OSHA REQUIREMENTS.

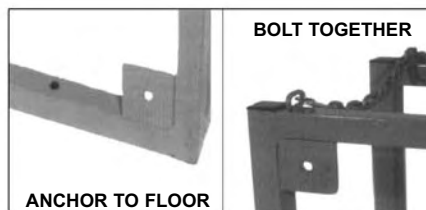

CYLINDER CAPACITY: 4



#66-MCR-400
HEIGHT: 30" WIDTH: 29" (O.D.)
DEPTH: 20" (O.D.) WEIGHT: 56 lbs.

CYLINDER CAPACITY: 6



#66-MCR-600
HEIGHT: 30" WIDTH: 29" (O.D.)
DEPTH: 30" (O.D.) WEIGHT: 65 lbs.

CYLINDER CAPACITY: 8



#66-MCR-800
HEIGHT: 30" WIDTH: 29" (O.D.)
DEPTH: 40" (O.D.) WEIGHT: 85 lbs.



#66-CH-200-C
HEIGHT: 48" DEPTH: 10" (O.D.)
WIDTH: 24" (O.D.) WEIGHT: 22 lbs.
DUAL CYLINDER



Cylinder Stands

D & E CYLINDER SIZES



Models **#66-6040**, **#66-6060** & **#66-6120** can be equipped with 75 lb. ea. load rated (plug in) locking casters for easy rolling over carpets or tile. Especially designed for use in laboratories, doctors and dentist offices, in the home, or where reserve cylinders are needed. This unique design allows for easy maintenance or replacement of damaged casters. These models become the **PC** series.

#66-6040-PC
 HEIGHT: 23" DEPTH: 12.5"
 WIDTH: 10.5" WEIGHT: 14 lbs.
 CYLINDER CAPACITY: 4

#66-6060-PC
 HEIGHT: 23" DEPTH: 12"
 WIDTH: 15" WEIGHT: 17 lbs.
 CYLINDER CAPACITY: 6

#66-6120-PC
 HEIGHT: 23" DEPTH: 15"
 WIDTH: 22" WEIGHT: 23 lbs.
 CYLINDER CAPACITY: 12

* HOLDS D OR E SIZE
 CYLINDERS ONLY.

Models **#66-6040**, **#66-6060**, **#66-6120**, **#66-6180**, **#66-6240** & **#66-6400** can be made with hinged lockable tops to help prevent theft, misuse or mixing of **D** or **E** cylinders while in storage. These models become the **LTL** series.



PLUG IN
 CASTERS

#66-6040-LTL
 HEIGHT: 35" DEPTH: 12.5"
 WIDTH: 10.5" WEIGHT: 23 lbs.
 CYLINDER CAPACITY: 4

#66-6060-LTL
 HEIGHT: 35" DEPTH: 12"
 WIDTH: 15" WEIGHT: 28 lbs.
 CYLINDER CAPACITY: 6

#66-6120-LTL
 HEIGHT: 35" DEPTH: 15"
 WIDTH: 22" WEIGHT: 32 lbs.
 CYLINDER CAPACITY: 12

#66-6180-LTL
 HEIGHT: 35" DEPTH: 15"
 WIDTH: 32" WEIGHT: 44 lbs.
 CYLINDER CAPACITY: 18

#66-6240-LTL
 HEIGHT: 35" DEPTH: 20"
 WIDTH: 32" WEIGHT: 55 lbs.
 CYLINDER CAPACITY: 24

#66-6400-LTL
 HEIGHT: 35" DEPTH: 40"
 WIDTH: 25" WEIGHT: 87 lbs.
 CYLINDER CAPACITY: 40

BUMPER GUARD KITS FOR ANTHONY M7, M9, C, D, & E SIZE CYL. STANDS



Anthony has developed a unique cylinder protection system for its multiple cylinder carts, cylinder stands and racks. These newly designed plastic bumper guards (PATENT PENDING) help protect the surfaces of steel and aluminum cylinders from being scratched, gouged, scraped, or marred. These bumpers also eliminate the clanging noise when cylinders are in transport. **NOTE:** These retrofit bumper guards easily snap into place and **do not come off.**

BUMPER GUARD KIT PART NO.	FITS ANTHONY MODELS	BUMPERS PER KIT	CYLINDER CAPACITY
#66-BG-4E	#66-6040, #66-6040-LTL, #66-6040-PC	24	4
#66-BG-6E	#66-6060, #66-6060-LTL, #66-6060-PC	34	6
#66-BG-12E	#66-6120, #66-6120-LTL, #66-6120-PC	62	12
#66-BG-18E	#66-6180, #66-6180-LTL	90	18
#66-BG-24E	#66-6240, #66-6240-LTL	116	24
#66-BG-40E	#66-6400, #66-6400-LTL	186	40

Cylinder Stands

These multiple M7, M9, C, D, & E size cylinder stands have been designed for use where there is a need for multiple cylinder storage and mobility is not a factor. The all-welded steel construction, combined with our newly designed tubular frame insures greater durability, strength and longer life of the unit.



#66-6040
 HEIGHT: 19.5" DEPTH: 12.5"
 WIDTH: 10.5" WEIGHT: 10 lbs.
 CYLINDER CAPACITY: 4



#66-6060
 HEIGHT: 19.5" DEPTH: 12"
 WIDTH: 15" WEIGHT: 13 lbs.
 CYLINDER CAPACITY: 6



#66-6120
 HEIGHT: 19.5" DEPTH: 15"
 WIDTH: 22" WEIGHT: 19 lbs.
 CYLINDER CAPACITY: 12



*Bolt down bars and feet
 on these models.*



#66-6240
 HEIGHT: 19.5" DEPTH: 20"
 WIDTH: 32" WEIGHT: 34 lbs.
 CYLINDER CAPACITY: 24

#66-6180 (not shown)
 HEIGHT: 19.5" DEPTH: 15"
 WIDTH: 32" WEIGHT: 24 lbs.
 CYLINDER CAPACITY: 18

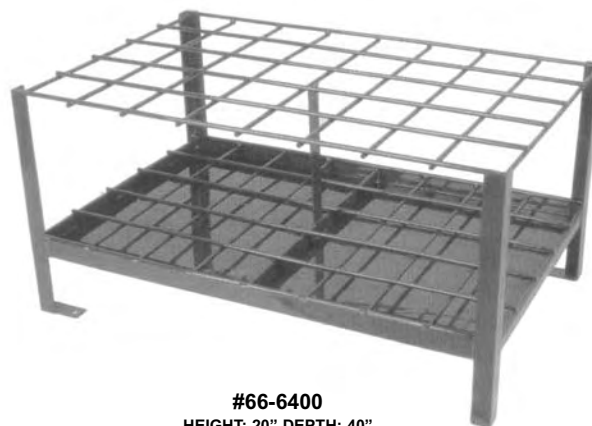

#66-6400
 HEIGHT: 20" DEPTH: 40"
 WIDTH: 25" WEIGHT: 67 lbs.
 CYLINDER CAPACITY: 40

Cylinder Stands

MODEL #66-610WC safely contains a D or E size cylinder that attaches to the rear of a wheelchair. This product features a very versatile adjusting device that allows this bracket to be used on the most popular wheelchairs on the market today. Also available in chrome plating. (Patent Applied)

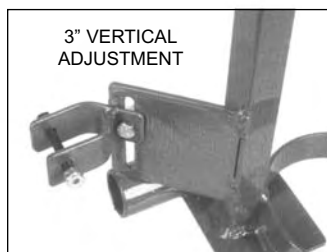

#66-610WC
HEIGHT: 14" DEPTH: 6"
WIDTH: 9" WEIGHT: 4 lbs.



#BR-65061
Multiple small cylinder delivery system, carries 4 small cylinders

MODEL #66-610WC-IV is a combination D or E size cylinder holder and I.V. Pole for most wheelchair applications. Total length of unit is 48". Also available in chrome plating.

#66-610WC-IV
HEIGHT: 48" DEPTH: 5"
WIDTH: 5" WEIGHT: 9 lbs.



Fiberglass Cylinder Bases

The finest stationary base system in the industry. Its lightweight strength and its easy-to-keep high-gloss finish have made fiberglass bases the choice for appearance and dependability. Tapered from top to bottom.



Item No.	Description	Size	Pkg.
#BR-65040	Small "E" or "D" base	4-7/16" to 4-3/8"	3/box
#BR-65043	Medium "M" base	7-5/8" to 7-3/8"	3/box
#BR-65044	Medium "S" base	7-5/8" straight wall	3/box
#BR-65045	"H" size base	9-1/2" - 9-1/4"	3/box
#BR-65050	"T" size base	9-1/2" straight wall	3/box
#BR-65043-A	Aluminum "M" size	8-1/4" to 7-5/8"	3/box